

500 Watt Non-Dimmable Power Supply

AL-PS-W-500-24



DESCRIPTION

Illuminate your world with confidence using our top-of-the-line 500-Watt Constant Voltage Power Supply. Expertly designed to deliver maximum efficiency and reliability, this UL-listed powerhouse ensures your LED lighting projects shine brighter and last longer.

Perfect for both residential and commercial environments, its tough aluminum casing safeguards performance in varied conditions. Enjoy hassle-free installation with its adaptable input range of 110-277VAC and an output of 24VDC, complete with a convenient six-foot power cord for ultimate flexibility.

KEY FEATURES



Output Power
500 Watts



IP Rating
IP67



Input Voltage
24VDC



Surface
Mounting Tabs

PRODUCT SPECIFICATION CHART

PHYSICAL		ELECTRICAL	
Length	10 1/8" (258mm) <i>excluding mounting tabs</i>	INPUT	
Width	4 5/16" (109mm)	AC Voltage Range	110-277VAC
Height	1 7/8" (48.5mm)	AC Current	5.1A @ 110VAC
Weight	6.4 lbs (2.9 kg)	Frequency Range	47/63Hz
Mounting Method	Mounting Tabs	Efficiency	>90.5%
Housing Material	Aluminum	Inrush Current	52A
Warranty	3 years	OUTPUT	
ENVIRONMENTAL		DC Voltage	24VDC
IP Rating	IP67	Max Output Current	20.84A
Max Operating Temp	-40°C to 60°C (-40°F to 140°F)	Max Output Power	500W
Max Storage Temp	-40°C to 80°C (-40°F to 176°F)	Minimum Load	400W
Suitable Uses	Dry, Damp, and Wet Locations	CONTROL	
STANDARDS/ CERTIFICATIONS	UL/cUL Listed, RoHS	Dimmable	No
		Dimming Compatibility	N/A

TECHNICAL DRAWINGS

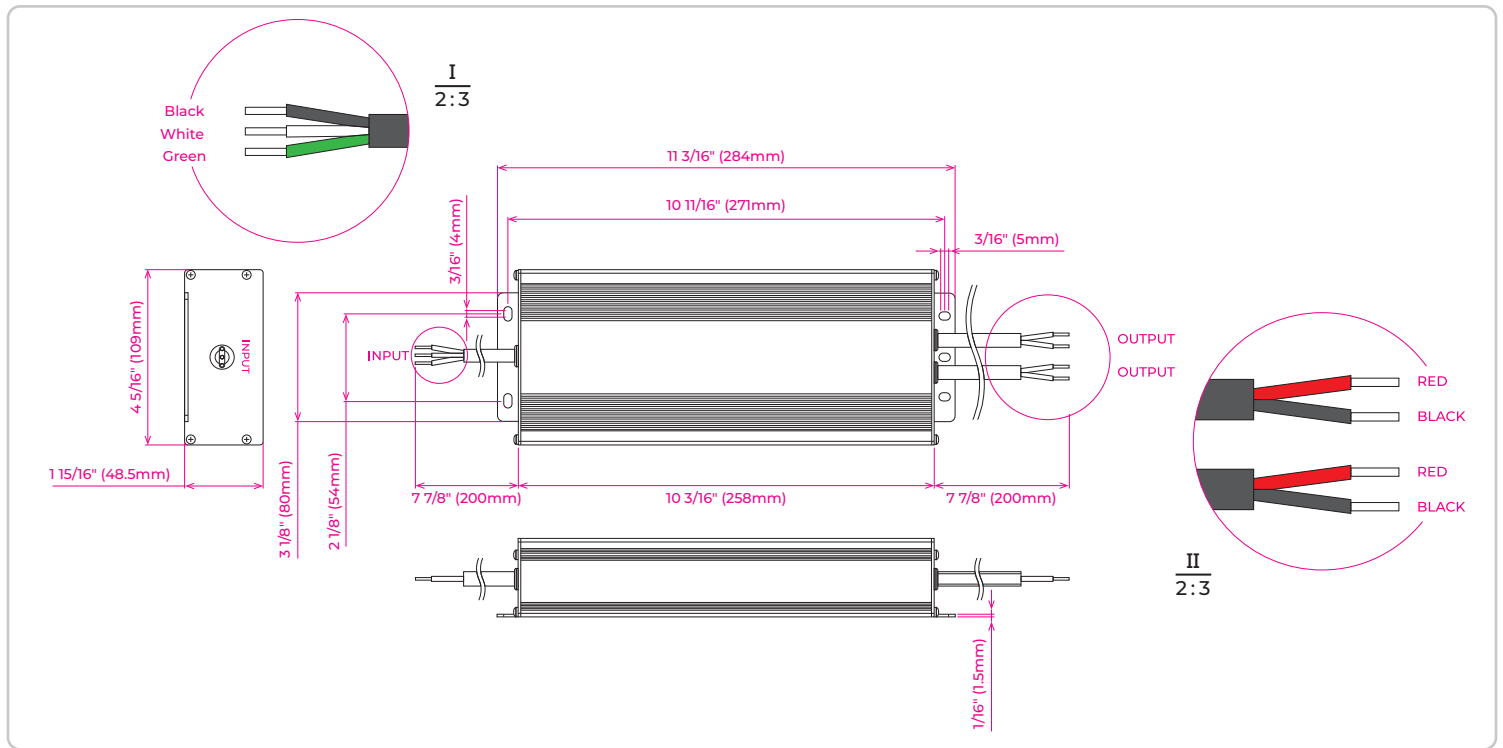

For general information purposes only. Specifications, dimensions and construction not guaranteed and are subject to change without notice.